

# 150mA Linear Regulator With Bypass Pin

## ■ FEATURES

- Guarantee 150mA Output Current.
- Fast Response in Line/Load Transient.
- Wide Operating Voltage Ranges: 2.0V to 6.0V.
- 0.01  $\mu$  A Shutdown Standby Current.
- Low Quiescent Current : 80 $\mu$ A.
- Output Voltage available within 1.1~4.2V.
- Low Dropout : 140mV at 150mA.
- PSRR : 60dB at 1kHz.
- Fixed: 1.1, 1.2, 1.3, 1.5, 1.8, 2.5, 2.7, 2.8, 2.85, 3.0, 3.3, 3.5, 3.7, 3.8 Output Voltage.
- Current Limit and Thermal Protection.
- Available in  $\pm$ 2% Output Tolerance.
- Available in 3 & 5 lead of SOT-23, TSOT23, SC70, & SOT-89 & DFN 6L 2x2 Package.

## ■ APPLICATIONS

- Cellular Phones.
- PCMCIA Cards
- Laptop, Palmtops, Notebook Computers
- Personal Communication Equipment.
- PDAs.
- Digital Still Cameras.
- Portable Consumer Equipments.

## ■ DESCRIPTION

AIC1746 is optimized for low ESR ceramic capacitor operation with 150mA continuous current. The AIC1746 is designed for portable RF and wireless applications with demanding performance and space requirements.

The AIC1746 offers high precision output voltage of  $\pm$ 2% tolerance. Output Voltage is available within 1.1~4.2V. There are version of 1.1, 1.2, 1.3, 1.5, 1.8, 2.5, 2.7, 2.8, 2.85, 3.0, 3.3, 3.5, 3.7 and 3.8 for a fixed output voltage.

A noise bypass pin is available for further reduction of output noise. At 150mA load current, a 140mV dropout can be performed. The quality of low quiescent current and low dropout voltage makes the device ideal for battery power applications. The high ripple rejection and low noise of the AIC1746 provide enhanced performances for critical applications such as cellular phones, and PDAs.

In addition, AIC1746's current limit and thermal protection provide protection against any overload condition that would cause excessive junction temperatures.

## ■ TYPICAL APPLICATION CIRCUIT

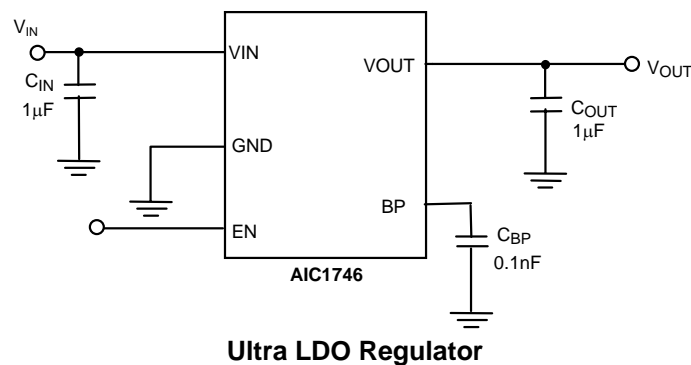

**ORDERING INFORMATION**

**3 pin:**

AIC1746-XXXXX XX

PACKING TYPE  
TR: TAPE & REEL  
BG: BAG

PACKAGE TYPE  
U3: SOT-23  
X3A: SOT-89  
X3T: SOT-89  
K3: TSOT23  
J3: SC70

P: Lead Free Commercial  
G: Green Package

(SC70 is only available on Green Package)

OUTPUT VOLTAGE

- 11: 1.1V
- 12: 1.2V
- 13: 1.3V
- 15: 1.5V
- 18: 1.8V
- 20: 2.0V
- 25: 2.5V
- 27: 2.7V
- 285: 2.85V
- 30: 3.0V
- 33: 3.3V
- 35: 3.5V
- 37: 3.7V
- 38: 3.8V

(Of a unit of 0.1V within 1.1~4.2V additional voltage versions are available on demand)

Example: AIC1746-18PX3ATR

→ 1.8V Version, in SOT-89 Lead Free Package & Tape & Reel Packing Type

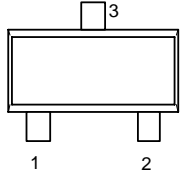
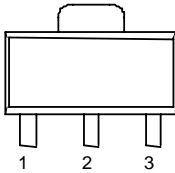
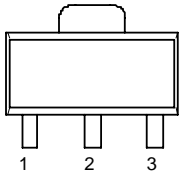
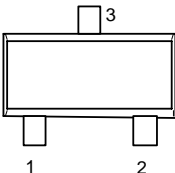
3 PIN CONFIGURATION	
<p>SOT-23/TSOT23 TOP VIEW 1: GND 2: VOUT 3: VIN</p>	
<p>SOT-89 (X3A) TOP VIEW 1: GND 2: VIN 3: VOUT</p>	
<p>SOT-89 (X3T) TOP VIEW 1: VOUT 2: GND 3: VIN</p>	
<p>SC70 TOP VIEW 1: GND 2: VOUT 3: VIN</p>	

**5 pin:**

AIC1746XXXXX XX

 PACKING TYPE  
 TR: TAPE & REEL  
 BG: BAG

 PACKAGE TYPE  
 V5 : SOT-23-5  
 V5N : SOT-23-5  
 X5 : SOT-89-5  
 K5 : TSOT23-5  
 K5N : TSOT23-5  
 J5 : SC70-5  
 DA : DFN 6L 2x2

 P: Lead Free Commercial  
 G: Green Package

 (SC70 and DFN are only  
 available on Green Package)



## OUTPUT VOLTAGE

- 11: 1.1V
- 12: 1.2V
- 13: 1.3V
- 15: 1.5V
- 18: 1.8V
- 20: 2.0V
- 25: 2.5V
- 27: 2.7V
- 285: 2.85V
- 30: 3.0V
- 33: 3.3V
- 35: 3.5V
- 37: 3.7V
- 38: 3.8V

 (Of a unit of 0.1V within  
 1.1~4.2V, additional voltage  
 versions are available on  
 demand)

Example: AIC1746-18PV5TR

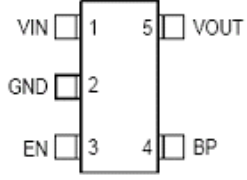
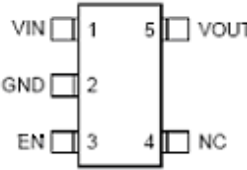
 → 1.8V Version, in SOT-23-5 Lead Free  
 Package & Tape & Reel Packing Type

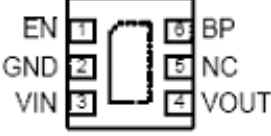
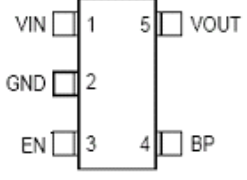
5 PIN CONFIGURATION	
SOT-23-5/TSOT23-5(V5/K5) TOP VIEW 1: VIN 2: GND 3: EN 4: BP 5: VOUT	
SOT-23-5/TSOT23-5(V5N/K5N) TOP VIEW 1: VIN 2: GND 3: EN 4: NC 5: VOUT	
SOT89-5(X5) TOP VIEW 1: VIN 2: GND 3: EN 4: NC 5: VOUT	
DFN 6L 2x2 TOP VIEW 1: EN 2: GND 3: VIN 4: VOUT 5: NC 6: BP	
SC70-5 TOP VIEW 1: VIN 2: GND 3: EN 4: BP 5: VOUT	

**●Marking**

Part No	Package Type	Marking
AIC1746-xxGJ3	SC70-3	Cxx
AIC1746-xxGJ5	SC70-5	Dxx
AIC1746-xxGDA	DFN 6L 2x2	FJxxG
AIC1746-xxPK3	TSOT-23	FLxxP
AIC1746-xxGK3	TSOT-23	FLxxG
AIC1746-xxPK5	TSOT-25	FMxxP
AIC1746-xxGK5	TSOT-25	FMxxG
AIC1746-xxPK5N	TSOT-25	FYxxP
AIC1746-xxGK5N	TSOT-25	FYxxG
AIC1746-xxPU3	SOT-23	FNxxP
AIC1746-xxGU3	SOT-23	FNxxG
AIC1746-xxPV5	SOT-25	FOxxP
AIC1746-xxGV5	SOT-25	FOxxG
AIC1746-xxPV5N	SOT-25	FWxxP
AIC1746-xxGV5N	SOT-25	FWxxG
AIC1746-xxPX3A	SOT-89-3	FPxxP
AIC1746-xxGX3A	SOT-89-3	FPxxG
AIC1746-xxPX3T	SOT-89-3	FQxxP
AIC1746-xxGX3T	SOT-89-3	FQxxG
AIC1746-xxPX5	SOT-89-5	FRxxP
AIC1746-xxGX5	SOT-89-5	FRxxG

Part No	Package Type	Marking
AIC1746-285GJ3	SC70-3	C2J
AIC1746-285GJ5	SC70-5	D2J
AIC1746-285GDA	DFN 6L 2x2	FJ2JG
AIC1746-285PK3	TSOT-23	FL2JP
AIC1746-285GK3	TSOT-23	FL2JG
AIC1746-285PK5	TSOT-25	FM2JP
AIC1746-285GK5	TSOT-25	FM2JG
AIC1746-285PK5N	TSOT-25	FY2JP
AIC1746-285GK5N	TSOT-25	FY2JG
AIC1746-285PU3	SOT-23	FN2JP
AIC1746-285GU3	SOT-23	FN2JG
AIC1746-285PV5	SOT-25	FO2JP
AIC1746-285GV5	SOT-25	FO2JG
AIC1746-285PV5N	SOT-25	FW2JP
AIC1746-285GV5N	SOT-25	FW2JG
AIC1746-285PX3A	SOT-89-3	FP2JP
AIC1746-285GX3A	SOT-89-3	FP2JG
AIC1746-285PX3T	SOT-89-3	FQ2JP
AIC1746-285GX3T	SOT-89-3	FQ2JG
AIC1746-285PX5	SOT-89-5	FR2JP
AIC1746-285GX5	SOT-89-5	FR2JG

xx represents output voltage. (11=1.1V, 12=1.2V ..... 42=4.2V)

**■ ABSOLUTE MAXIMUM RATINGS**

Input Voltage .....	7V
EN Pin Voltage .....	7V
Noise Bypass Terminal Voltage .....	7V
Power Dissipation, $P_D$ @ $T_A = 25^\circ\text{C}$	
SOT23-5 .....	400mW
TSOT23-5 .....	400mW
SC70-5.....	300mW
DFN 6L 2x2 .....	606mW
Maximum Junction Temperature.....	150°C
Operating Temperature Range .....	-40°C~85°C
Storage Temperature Range .....	-65°C~150°C
Lead Temperature (Soldering, 10 sec) .....	260°C
Thermal Resistance - Junction to Case, $R_{\theta_{JC}}$	
SOT-23-5 .....	115° C /W
TSOT23-5 .....	115° C /W
DFN 6L 2x2 .....	30° C /W
Thermal Resistance - Junction to Ambient, $R_{\theta_{JA}}$	
SOT-23-5.....	250° C /W
TSOT23-5.....	250° C /W
SC-70-5 .....	333° C /W
DFN 6L 2x2 .....	165° C /W

(Assume no ambient airflow, no heatsink)

**Absolute Maximum Ratings are those values beyond which the life of a device may be impaired.**

**■ TEST CIRCUIT**

Refer to the TYPICAL APPLICATION CIRCUIT.

**ELECTRICAL CHARACTERISTICS**
**( $C_{IN} = C_{OUT} = 1\mu F$ ,  $C_{BP} = 0.1nF$ ,  $V_{IN} = V_{OUT} + 1V$ ,  $T_J = 25^\circ C$ , unless otherwise specified) (Note 1)**

PARAMETER	TEST CONDITIONS	SYMBOL	MIN.	TYP.	MAX.	UNIT
Input Voltage (Note 2)		$V_{IN}$	2		6	V
Output Voltage Tolerance	$V_{IN}=6V$ , $I_{OUT} = 1mA$	$V_{OUT}$	-2		2	%
Continuous Output Current		$I_{OUT}$	150			mA
Quiescent Current	$V_{EN} \geq 1.2V$ , $I_{OUT} = 0 mA$	$I_Q$		80	110	$\mu A$
GND Pin Current	$I_{OUT} = 150mA$	$I_{GND}$		80		$\mu A$
Standby Current	$V_{EN} = 0$	$I_{STBY}$		0.01	0.5	$\mu A$
Output Current Limit	$V_{in}=5V$ $R_{LOAD} = 1\Omega$	$I_{IL}$	180	300	500	mA
Dropout Voltage	$I_{OUT} = 150 mA$ , $V_{OUT}=1.2V$	$V_{DROP}$		460	700	mV
	$I_{OUT} = 150 mA$ , $V_{OUT}=1.8V$			230	340	
	$I_{OUT} = 150 mA$ , $V_{OUT}=3.3V$			140	220	
Line Regulation	$V_{IN} = V_{OUT} + 1V$ to 6V	$\Delta V_{LIR}$		3	10	mV
Load Regulation	$I_{OUT} = 1mA$ to 150mA	$\Delta V_{LOR}$		5	20	mV
Ripple Rejection	$f=1KHz$ , Ripple=0.5Vp-p,	PSRR		-60		dB
	$f=10KHz$ , Ripple=0.5Vp-p,			-55		
Temperature Coefficient		TC		50		ppm/ $^\circ C$
Thermal Shutdown Temperature	$V_{IN} = V_{OUT} + 1V$	$T_{SD}$		150		$^\circ C$
Thermal Shutdown Hysteresis		$\Delta T_{SD}$		20		$^\circ C$
<b>Shutdown Pin SPECIFICATIONS</b>						
Shutdown Pin Current	$V_{EN} = V_{IN}$ or GND	$I_{EN}$		0	100	nA
Shutdown Exit Delay Time	$I_{OUT} = 30mA$	$\Delta t$		50		$\mu S$
Max Output Discharge Resistance to GND during Shutdown		$R_{DSON\_CLMP}$			700	$\Omega$
Shutdown Time				30		$\mu S$
Shutdown Input Threshold	Output ON, $V_{IN} = 2.2V$ to 5.5V	$V_{ENH}$	1.2			V
	Output OFF, $V_{IN} = 2.2V$ to 5.5V	$V_{ENL}$			0.4	

**Note 1.** Specifications are production tested at  $T_A = 25^\circ C$ . Specifications over the  $-40^\circ C$  to  $85^\circ C$  operating temperature range are assured by design, characterization and correlation with Statistical Quality Controls (SQC).

**Note 2.**  $V_{in(min)}$  is the higher value of  $V_{out} + \text{Dropout Voltage}$  or 2.0V.

**TYPICAL PERFORMANCE CHARACTERISTICS**

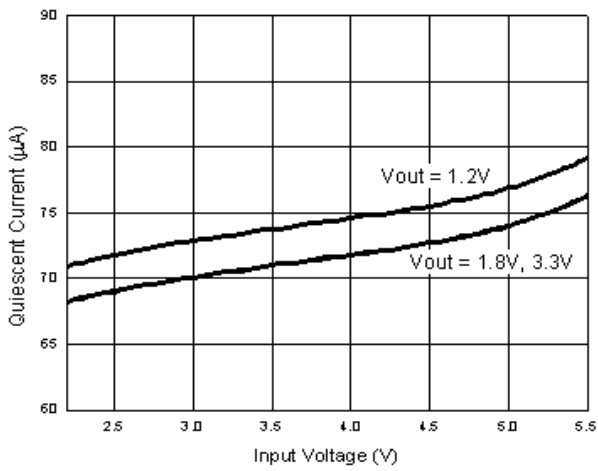

Fig. 1 Quiescent Current VS Input Voltage

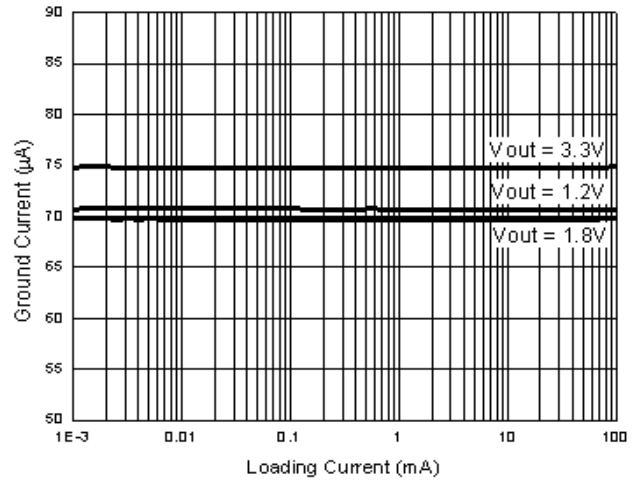

Fig. 2 Ground Current VS Loading Current

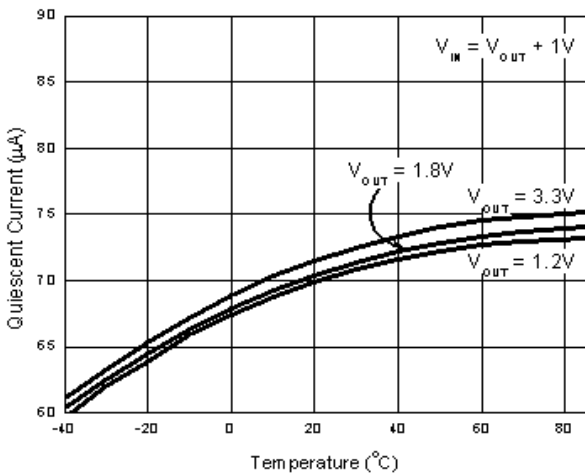

Fig. 3 Quiescent Current VS Temperature

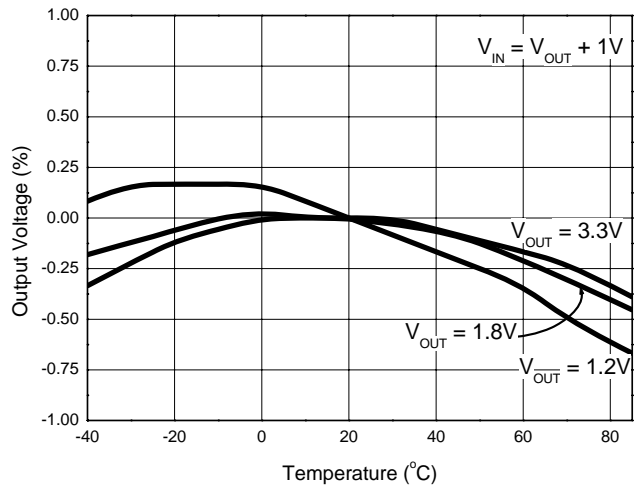

Fig. 4 Output Voltage VS Temperature

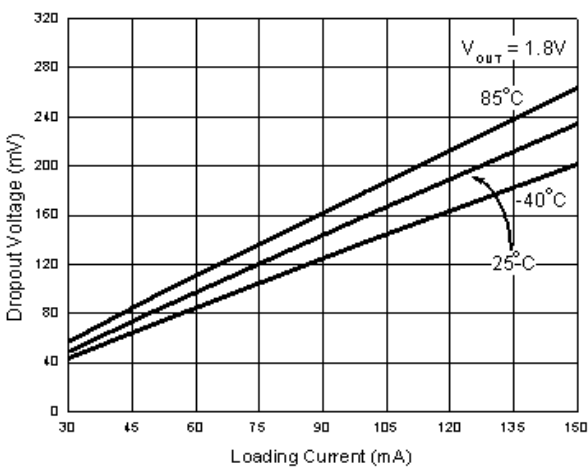

Fig.5 Dropout Voltage VS Loading Current (1.8V)

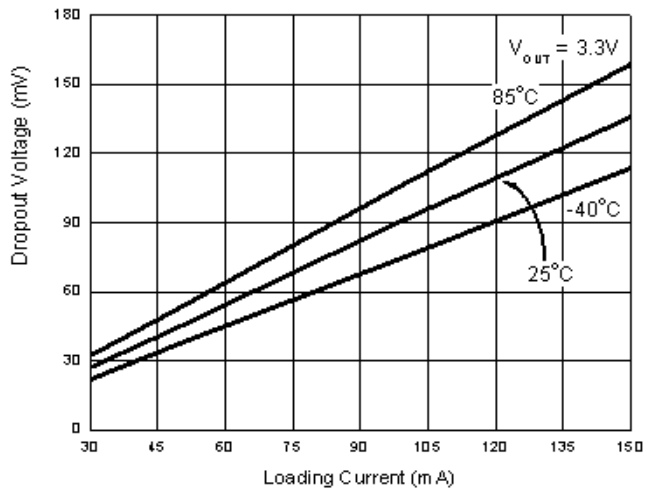

Fig.6 Dropout Voltage VS Loading Current (3.3V)

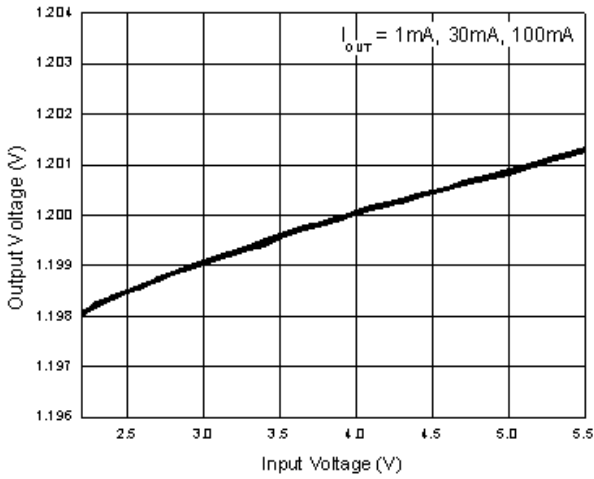

Fig. 7 Output Voltage VS Input Voltage (1.2V)

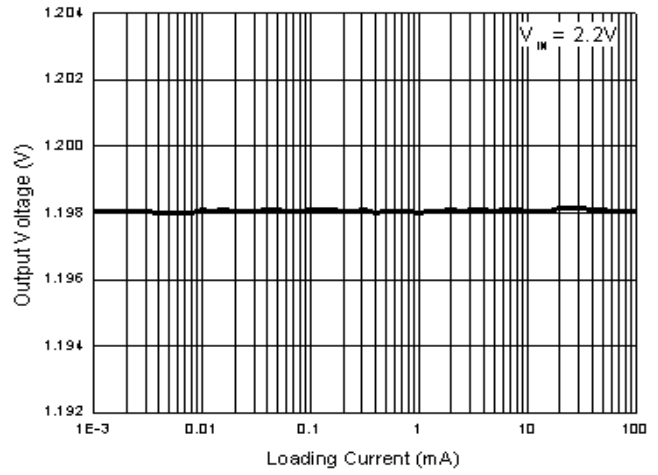

Fig. 8 Output Voltage VS Loading Current (1.2V)

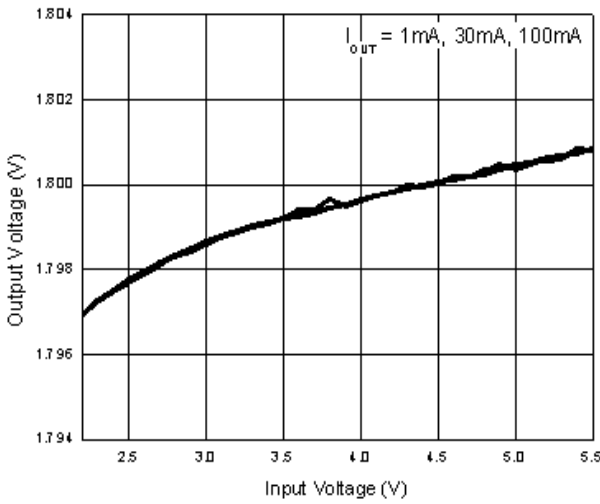

Fig.9 Output Voltage VS Input Voltage (1.8V)

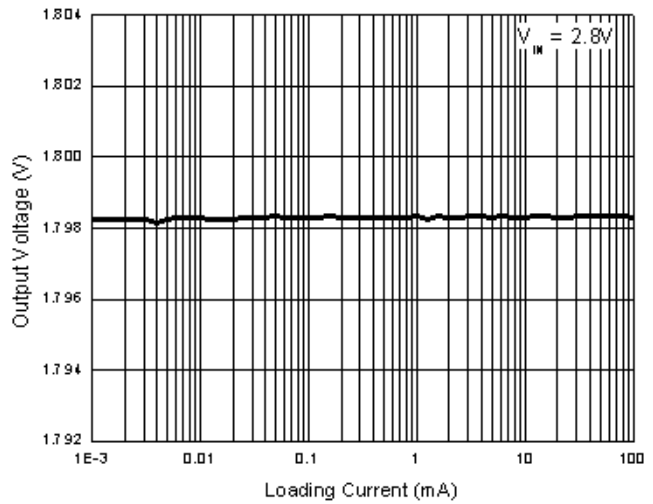

Fig.10 Output Voltage VS Loading Current (1.8V)

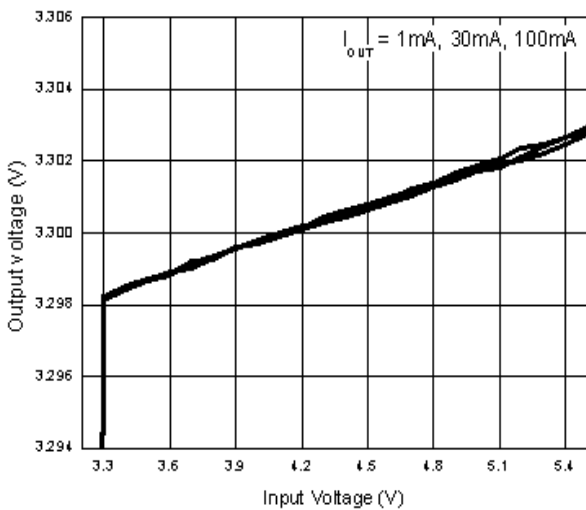

Fig.11 Output Voltage VS Input Voltage (3.3V)

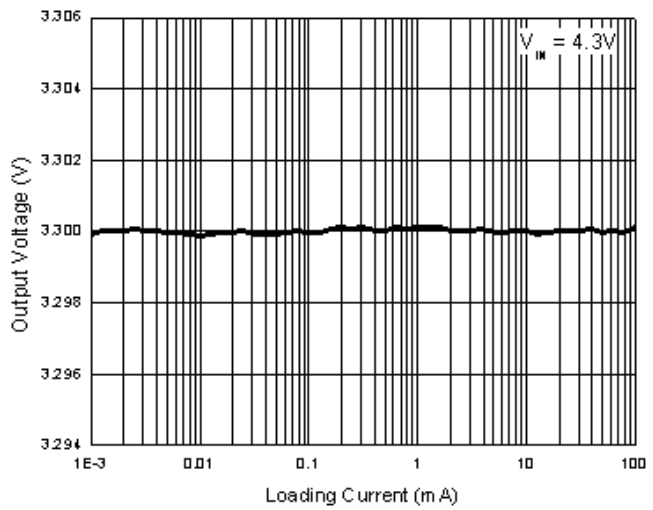

Fig.12 Output Voltage VS Loading Current (3.3V)



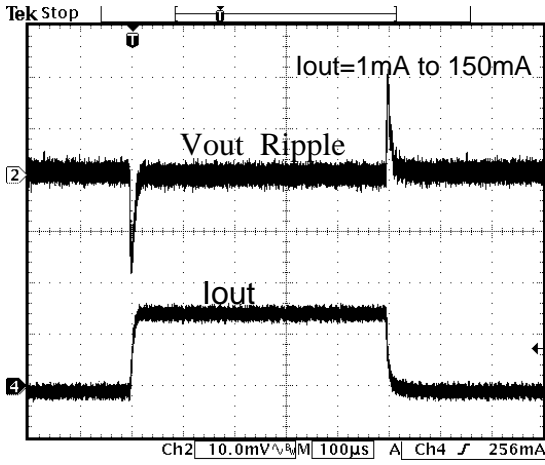

Fig. 13 Load Transient Response (1.2V)

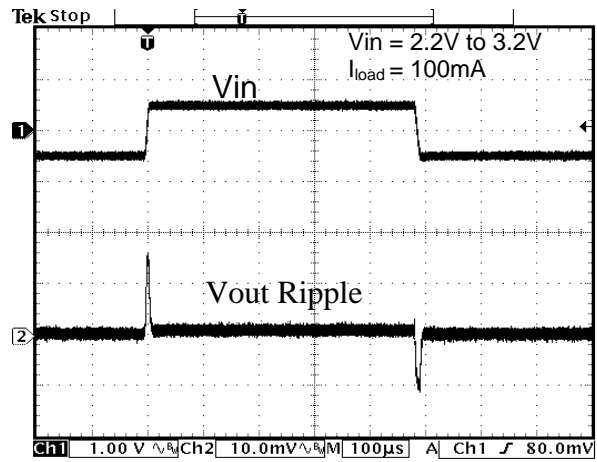

Fig. 14 Line Transient Response (1.2V)

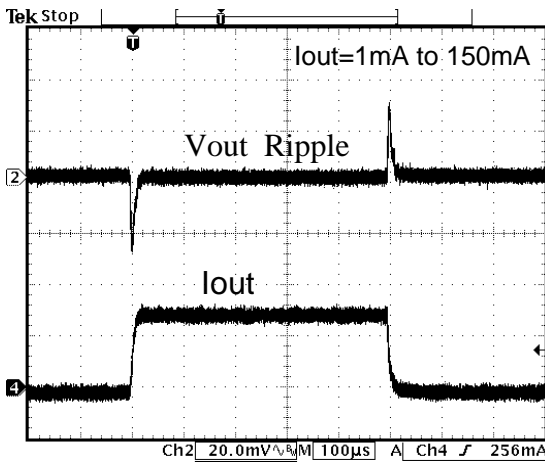

Fig. 15 Load Transient Response (1.8V)

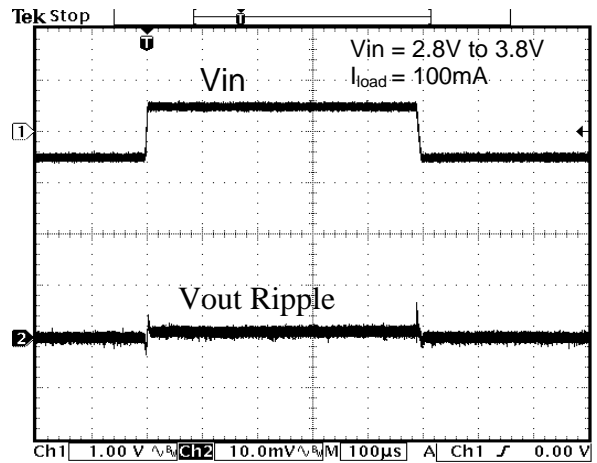

Fig. 16 Line Transient Response (1.8V)

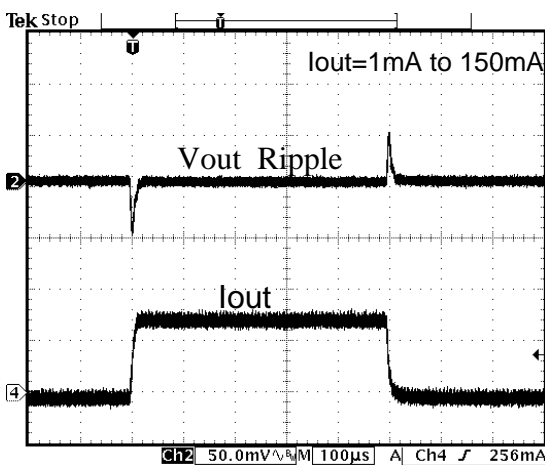

Fig. 17 Load Transient Response (3.3V)

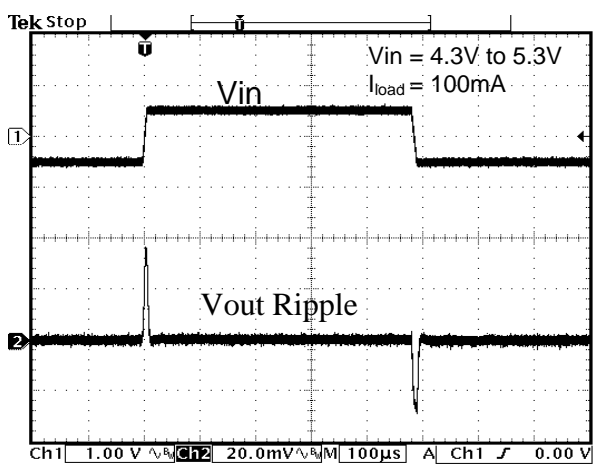

Fig. 18 Line Transient Response (3.3V)

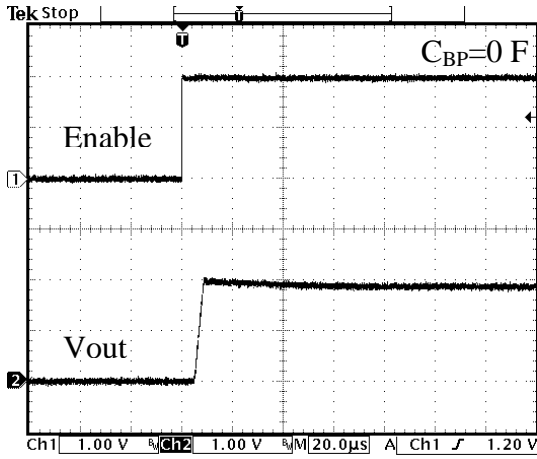

Fig. 19 Start-up Waveform

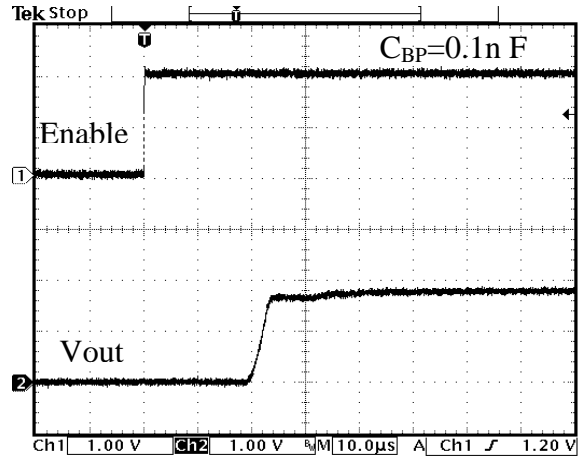

Fig. 20 Start-up Waveform

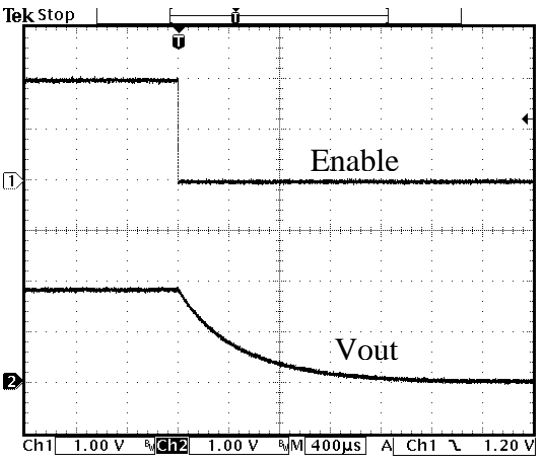
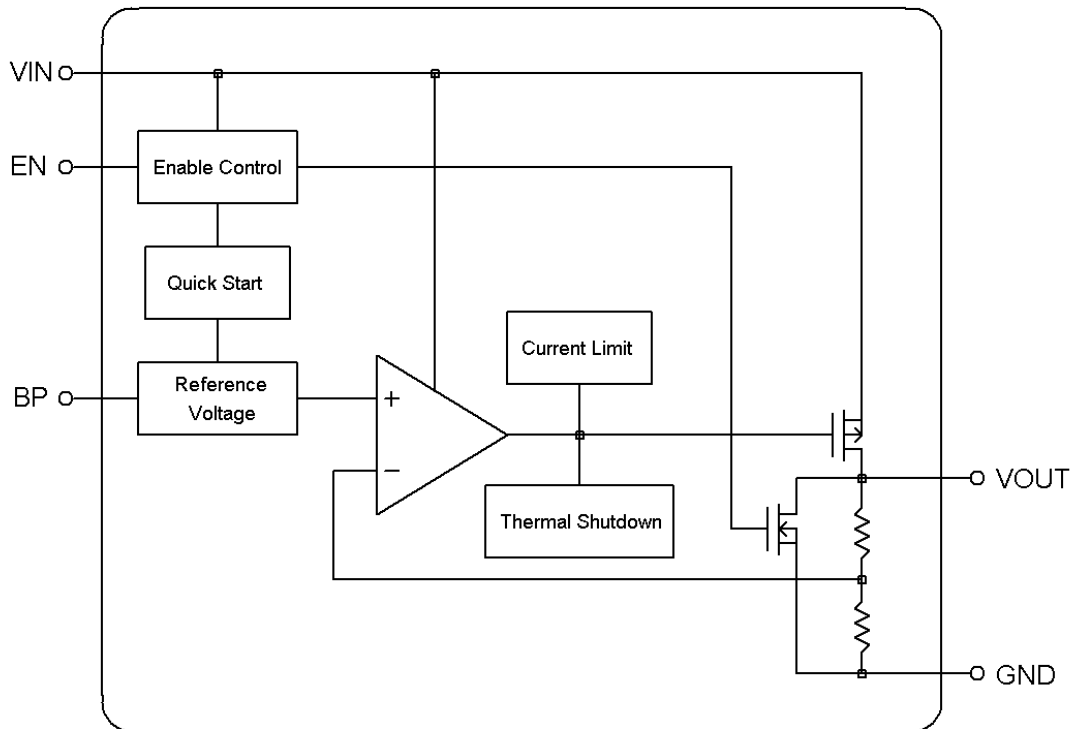

Fig. 21 Shutdown Waveform

**■ BLOCK DIAGRAM**

**■ PIN DESCRIPTION**

VIN - Power supply input pin. Bypass with a 1 $\mu$ F capacitor to GND

GND - Ground.

EN - Active High Shutdown Input.

VOUT - Regulator Output pin. Sources up to 150 mA.

BP - Bypass pin. It should be connected to external 0.1nF capacitor to GND to reduce output noise.

## ■ DETAILED DESCRIPTION OF TECHNICAL TERMS

### ***DROPOUT VOLTAGE ( $V_{DROP}$ )***

The dropout voltage is defined as the difference between input voltage and output voltage at which point the regulator starts to fall out of regulation. Below this value, the output voltage will fall while the input voltage is reduced. It depends on the load current and junction temperature. The dropout voltage is specified at which the output voltage drops 100mV below the value measured with 1V difference.

### ***LINE REGULATION***

Line regulation is the ability of the regulator to maintain a constant output voltage as the input voltage changes. The line regulation is specified as the input voltage is changed from  $V_{IN} = V_{OUT} + 1\text{ V}$  to 6V and  $I_{OUT} = 1\text{ mA}$ .

### ***LOAD REGULATION***

Load regulation is the ability of the regulator to maintain a constant output voltage as the load current changes. To minimize temperature

effects, it is a pulsed measurement with the input voltage set to  $V_{IN} = V_{OUT} + 1\text{ V}$ . The load regulation is specified under the output current step of 0.1mA to 150mA.

### ***CURRENT LIMIT ( $I_{IL}$ )***

The AIC1746 includes a current limiting, which monitors and controls the maximum output current if the output is shorted to ground. This can protect the device from being damaged.

### ***THERMAL PROTECTION***

The thermal sensor protects the device when the junction temperature exceeds  $T_J = +150^\circ\text{C}$ . It signals, the shutdown logic, turning off the pass transistor and allowing the IC to cool. Thermal protection is designed to protect the device in the event of fault conditions. For continuous operation do not exceed the absolute maximum junction-temperature rating of  $T_J = 150^\circ\text{C}$ , or damage the device.

## ■ APPLICATION INFORMATION

### INPUT-OUTPUT CAPACITORS

Linear regulators require input and output capacitors to maintain stability. Input capacitor at 1 $\mu$ F with 1 $\mu$ F output capacitor is recommended.

### POWER DISSIPATION

The AIC1746 obtains thermal-limiting circuitry, which is designed to protect the device against overload condition. For continuous load condition, maximum rating of junction temperature must not be exceeded. It is important to pay more attention in thermal resistance. It includes junction to case, junction to ambient. The maximum power dissipation of AIC1746 depends on the thermal resistance of its case and circuit board, the temperature difference between the die junction and ambient air, and the rate of airflow. The rate of temperature rise is greatly affected by the mounting pad configuration on the PCB, the board material, and the ambient temperature. When the IC mounting with good thermal

conductivity is used, the junction temperature will be low even when large power dissipation applies.

The power dissipation across the device is

$$P = I_{OUT} (V_{IN} - V_{OUT}).$$

The maximum power dissipation is:

$$P_{MAX} = \frac{(T_{J-max} - T_A)}{R\theta_{JA}}$$

Where  $T_{J-max}$  is the maximum allowable junction temperature (150°C), and  $T_A$  is the ambient temperature suitable in application.

As a general rule, the lower temperature is, the better reliability of the device is. So the PCB mounting pad should provide maximum thermal conductivity to maintain low device temperature. GND pin performs a dual function for providing an electrical connection to ground and channeling heat away. Therefore, connecting the GND pin to ground with a large pad or ground plane would increase the power dissipation and reduce the device temperature.

■ PHYSICAL DIMENSIONS

● SOT-89 PACKAGE OUTLINE DRAWING

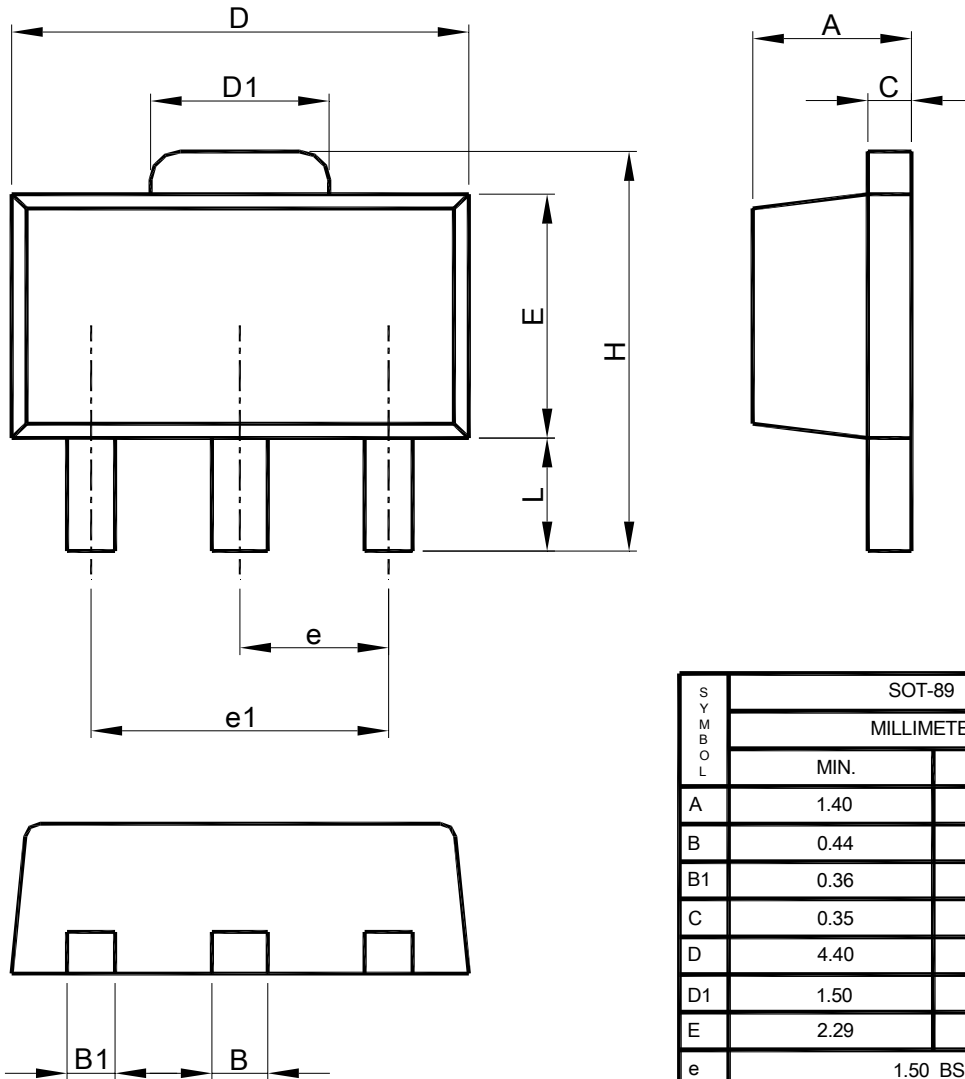

SYMBOL	SOT-89	
	MILLIMETERS	
	MIN.	MAX.
A	1.40	1.60
B	0.44	0.56
B1	0.36	0.48
C	0.35	0.44
D	4.40	4.60
D1	1.50	1.83
E	2.29	2.60
e	1.50 BSC	
e1	3.00 BSC	
H	3.94	4.25
L	0.89	1.20

- Note: 1. Refer to JEDEC TO-243AA.  
 2. Dimension "D" does not include mold flash, protrusions or gate burrs. Mold flash, protrusion or gate burrs shall not exceed 6 mil per side.  
 3. Dimension "E" does not include inter-lead flash or protrusions.  
 4. Controlling dimension is millimeter, converted inch dimensions are not necessarily exact.

● SOT-89- 5PIN PACKAGE OUTLINE DRAWING

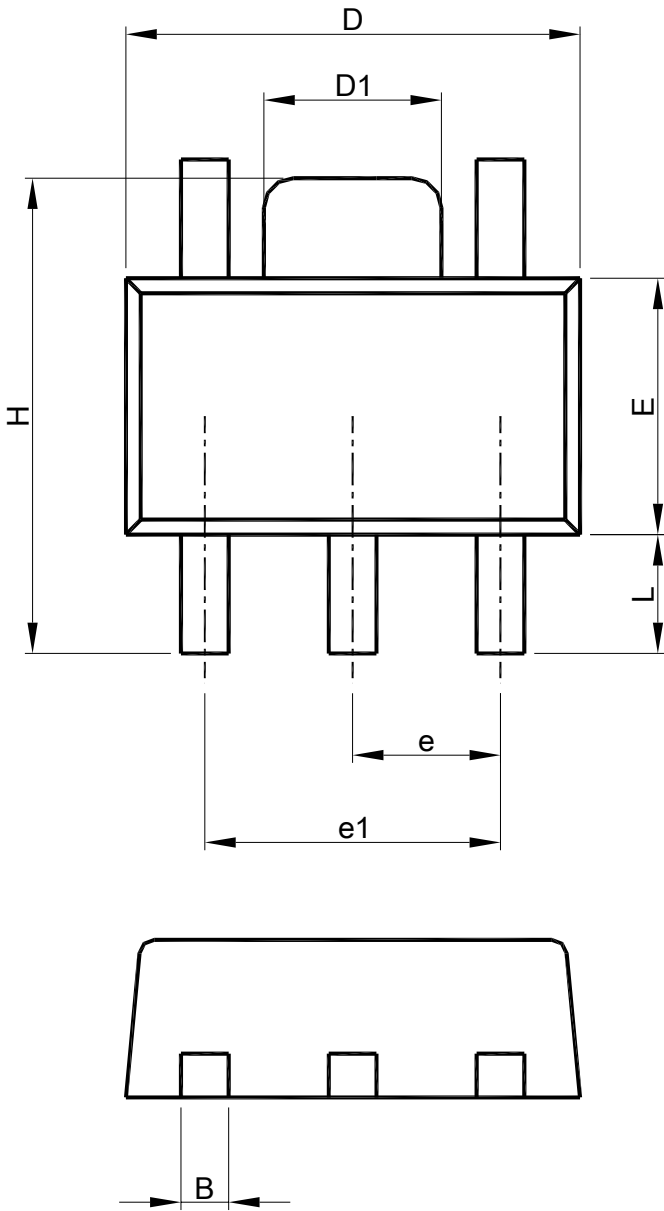

SYMBOL	SOT-89-5	
	MILLIMETERS	
	MIN.	MAX.
A	1.40	1.60
B	0.36	0.56
C	0.35	0.44
D	4.40	4.60
D1	1.50	1.83
E	2.29	2.60
e	1.50 BSC	
e1	3.00 BSC	
H	3.94	4.25
L	0.80	1.20

- Note: 1. Refer to JEDEC TO-243AA.  
 2. Dimension "D" does not include mold flash, protrusions or gate burrs. Mold flash, protrusion or gate burrs shall not exceed 6 mil per side.  
 3. Dimension "E" does not include inter-lead flash or protrusions.  
 4. Controlling dimension is millimeter, converted inch dimensions are not necessarily exact.

● TSOT23 PACKAGE OUTLINE DRAWING

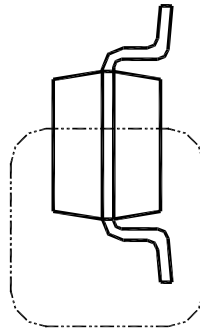
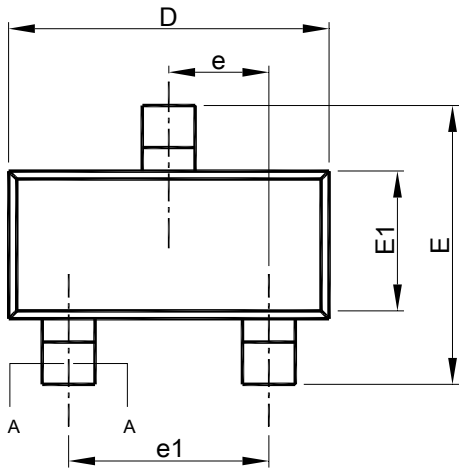

SEE VIEW B

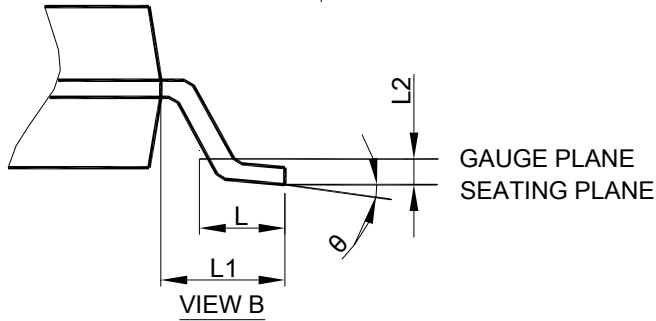
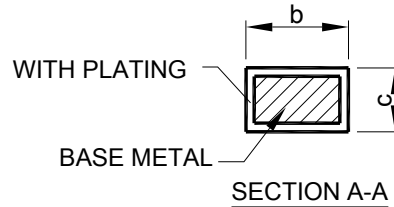
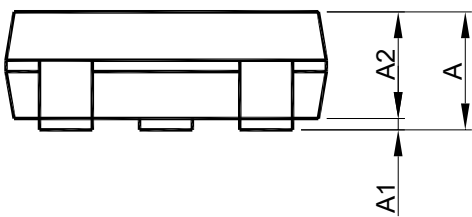

SYMBOL	TSOT-23	
	MILLIMETERS	
	MIN.	MAX.
A	-	1.00
A1	0	0.10
A2	0.70	0.90
b	0.30	0.50
c	0.08	0.22
D	2.80	3.00
E	2.60	3.00
E1	1.50	1.70
e	0.95 BSC	
e1	1.90 BSC	
L	0.30	0.60
L1	0.60 REF	
L2	0.25 BSC	
θ	0°	8°

- Note :
1. Refer to JEDEC MO-193C.
  2. Dimension "D" does not include mold flash, protrusions or gate burrs. Mold flash, protrusion or gate burrs shall not exceed 6 mil per side.
  3. Dimension "E1" does not include inter-lead flash or protrusions.
  4. Controlling dimension is millimeter, converted inch dimensions are not necessarily exact.



● TSOT23- 5PIN PACKAGE OUTLINE DRAWING

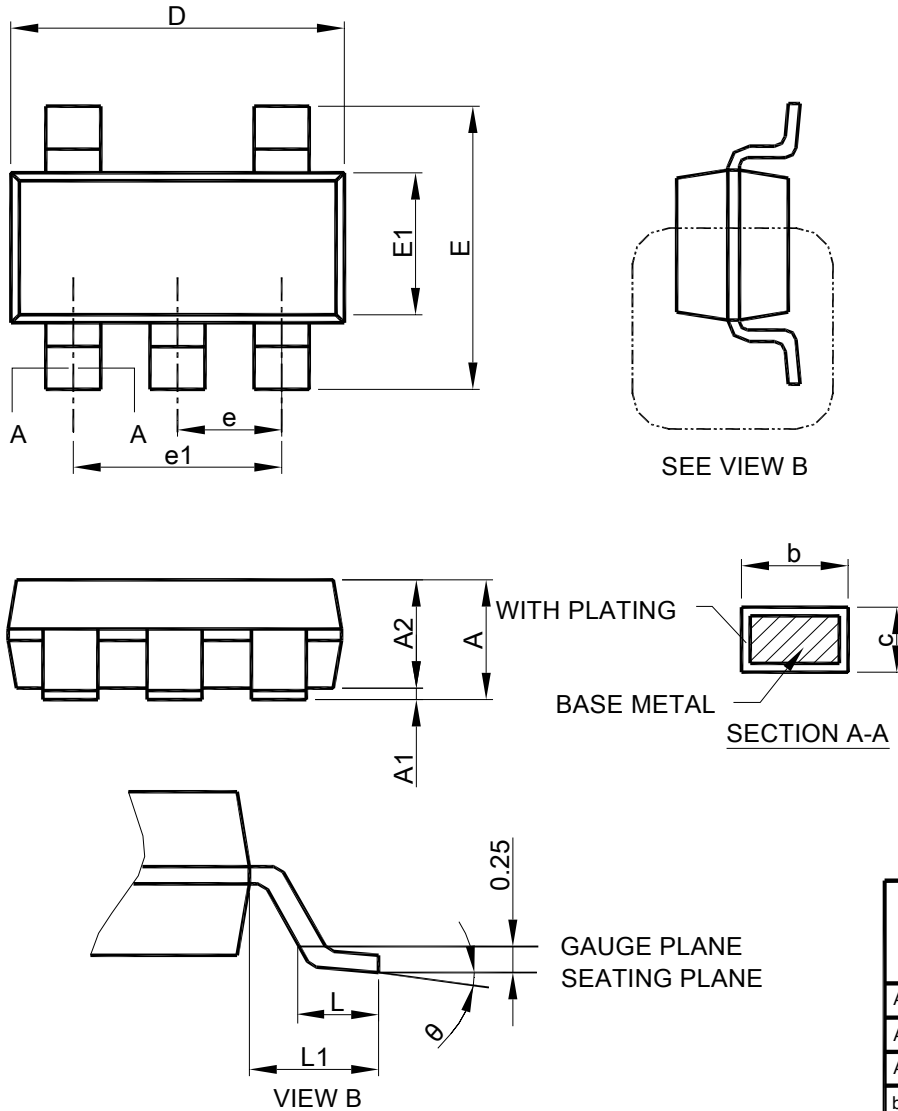

Note : 1. Refer to JEDEC MO-193AB.

2. Dimension "D" does not include mold flash, protrusions or gate burrs. Mold flash, protrusion or gate burrs shall not exceed 6 mil per side.
3. Dimension "E1" does not include inter-lead flash or protrusions.
4. Controlling dimension is millimeter, converted inch dimensions are not necessarily exact.

SYMBOL	TSOT-23-5	
	MILLIMETERS	
	MIN.	MAX.
A	-	1.00
A1	0	0.10
A2	0.70	0.90
b	0.30	0.50
c	0.08	0.22
D	2.80	3.00
E	2.60	3.00
E1	1.50	1.70
e	0.95 BSC	
e1	1.90 BSC	
L	0.30	0.60
L1	0.60 REF	
θ	0°	8°

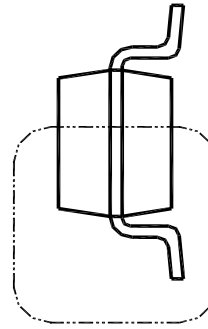
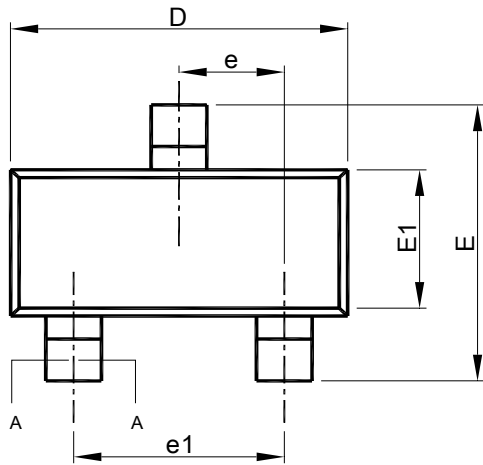
**● SOT-23 PACKAGE OUTLINE DRAWING**

SEE VIEW B

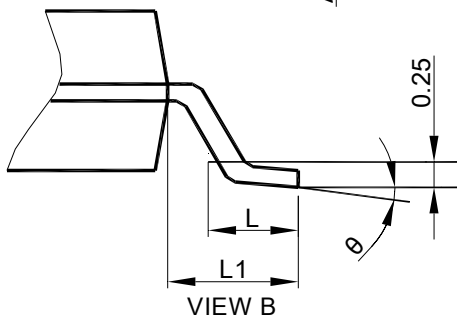
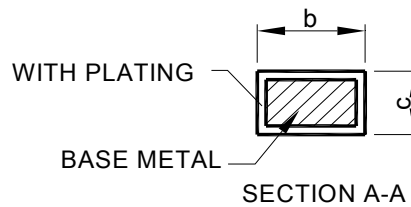
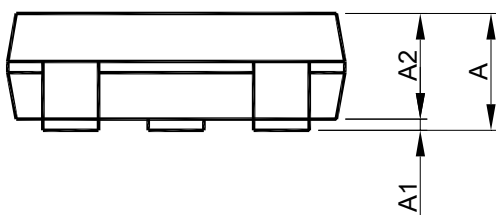
 GAUGE PLANE  
SEATING PLANE

SYMBOL	SOT-23	
	MILLIMETERS	
	MIN.	MAX.
A	0.95	1.45
A1	0.05	0.15
A2	0.90	1.30
b	0.30	0.50
c	0.08	0.22
D	2.80	3.00
E	2.60	3.00
E1	1.50	1.70
e	0.95 BSC	
e1	1.90 BSC	
L	0.30	0.60
L1	0.60 REF	
θ	0°	8°

Note: 1. Refer to JEDEC MO-178.

2. Dimension "D" does not include mold flash, protrusions or gate burrs. Mold flash, protrusion or gate burrs shall not exceed 10 mil per side.

3. Dimension "E1" does not include inter-lead flash or protrusions.

4. Controlling dimension is millimeter, converted inch dimensions are not necessarily exact.

● SOT-23- 5PIN PACKAGE OUTLINE DRAWING

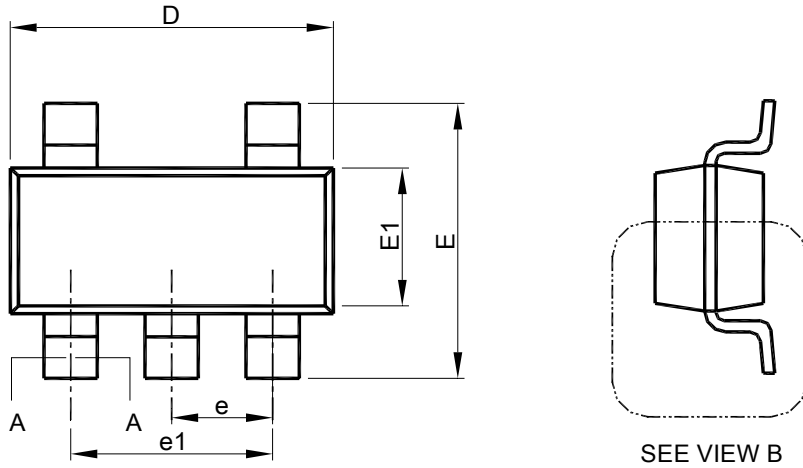

SEE VIEW B

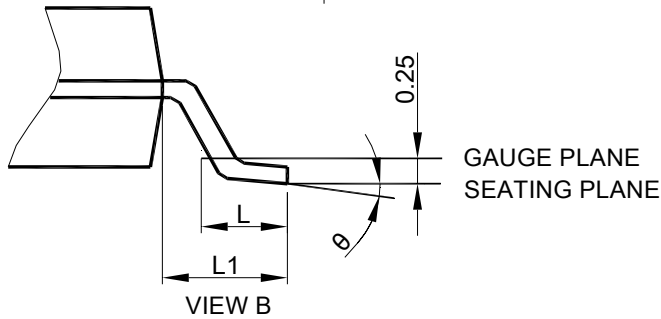
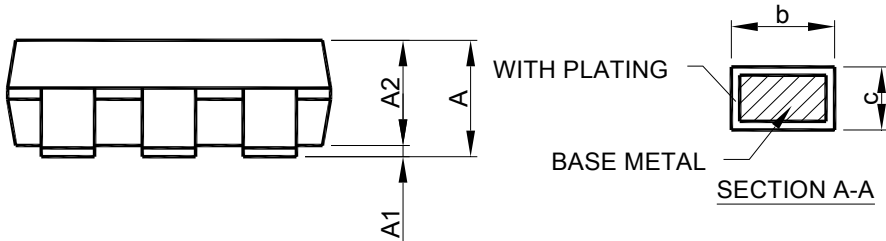

VIEW B

SYMBOL	SOT-23-5	
	MILLIMETERS	
	MIN.	MAX.
A	0.95	1.45
A1	0.05	0.15
A2	0.90	1.30
b	0.30	0.50
c	0.08	0.22
D	2.80	3.00
E	2.60	3.00
E1	1.50	1.70
e	0.95 BSC	
e1	1.90 BSC	
L	0.30	0.60
L1	0.60 REF	
q	0°	8°

- Note :
1. Refer to JEDEC MO-178AA.
  2. Dimension "D" does not include mold flash, protrusions or gate burrs. Mold flash, protrusion or gate burrs shall not exceed 10 mil per side.
  3. Dimension "E1" does not include inter-lead flash or protrusions.
  4. Controlling dimension is millimeter, converted inch dimensions are not necessarily exact.

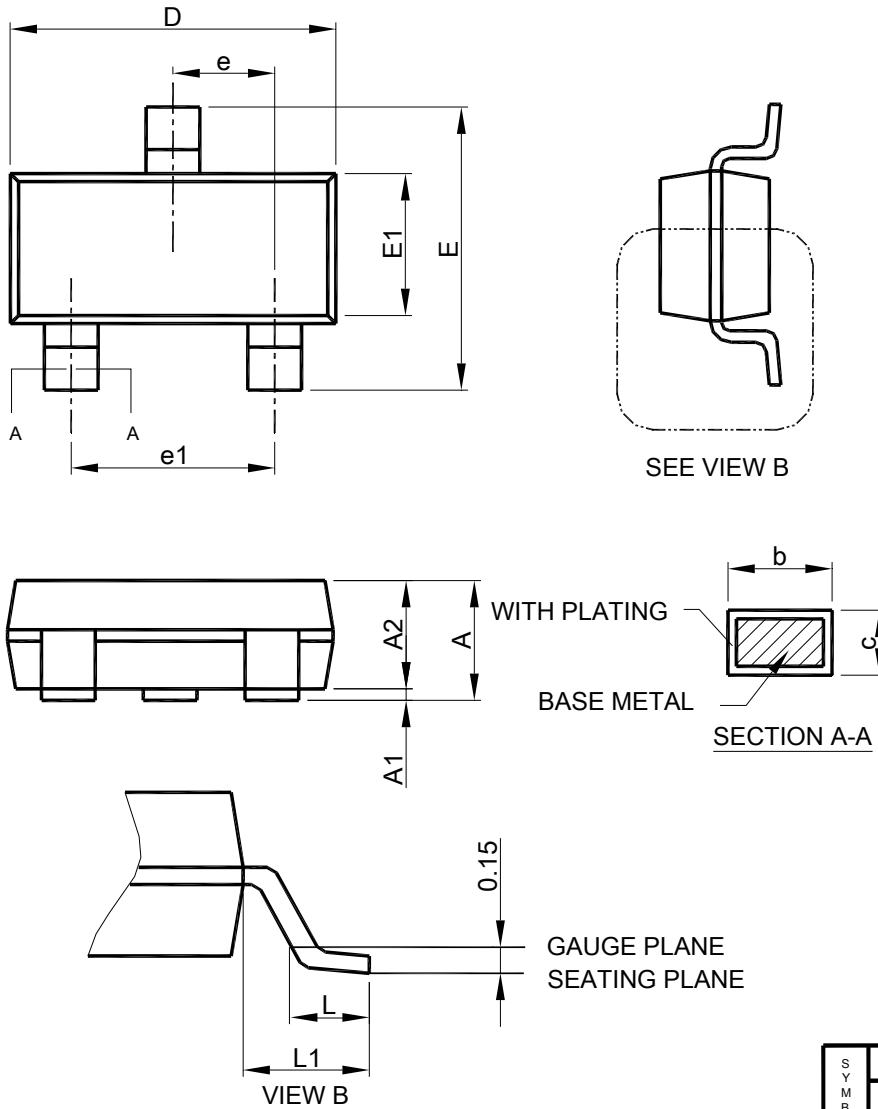
**● SC70-3PIN PACKAGE OUTLINE DRAWING**

- Note: 1. Refer to JEDEC MO-203.  
 2. Dimension "D" does not include mold flash, protrusions or gate burrs. Mold flash, protrusion or gate burrs shall not exceed 6 mil per side.  
 3. Dimension "E1" does not include inter-lead flash or protrusions.  
 4. Controlling dimension is millimeter, converted inch dimensions are not necessarily exact.

SYMBOL	SC70-3L	
	MILLIMETERS	
	MIN.	MAX.
A	-	1.10
A1	0	0.10
A2	0.70	1.00
b	0.15	0.40
c	0.08	0.25
D	1.85	2.15
E	1.80	2.40
E1	1.10	1.40
e	0.65 BSC	
e1	1.30 BSC	
L	0.26	0.46
L1	0.42 REF	

● SC70 - 5PIN PACKAGE OUTLINE DRAWING

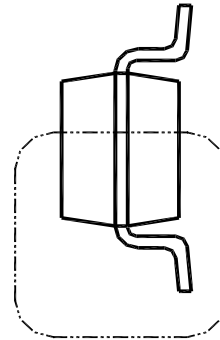
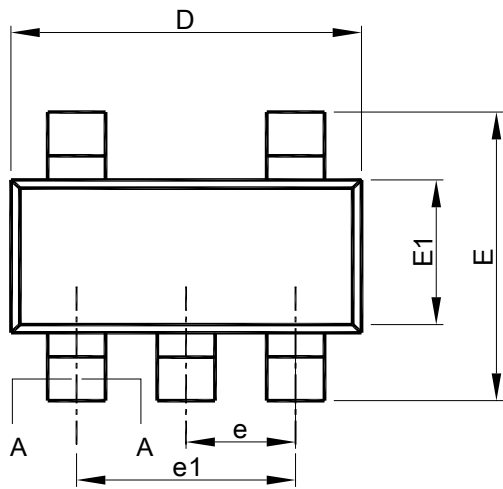

SEE VIEW B

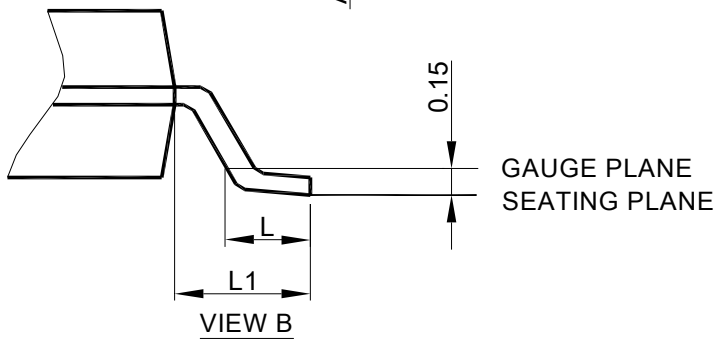
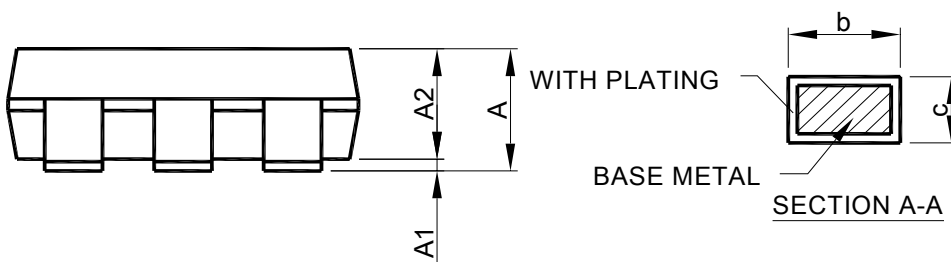

SYMBOL	SC70-5L	
	MILLIMETERS	
	MIN.	MAX.
A	-	1.10
A1	0	0.10
A2	0.70	1.00
b	0.15	0.30
c	0.08	0.25
D	1.85	2.15
E	1.80	2.40
E1	1.10	1.40
e	0.65 BSC	
e1	1.30 BSC	
L	0.26	0.46
L1	0.42 REF	

- Note: 1. Refer to JEDEC MO-203AA.  
 2. Dimension "D" does not include mold flash, protrusions or gate burrs. Mold flash, protrusion or gate burrs shall not exceed 6 mil per side.  
 3. Dimension "E1" does not include inter-lead flash or protrusions.  
 4. Controlling dimension is millimeter, converted inch dimensions are not necessarily exact.

● DFN 6L 2x2 PACKAGE OUTLINE DRAWING

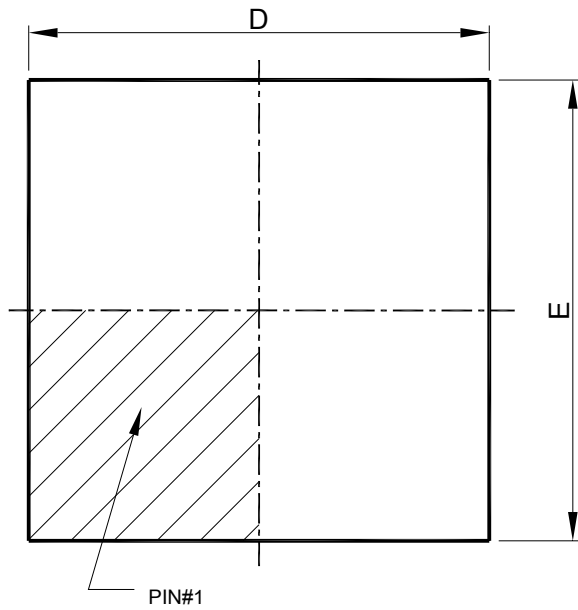

TOP VIEW

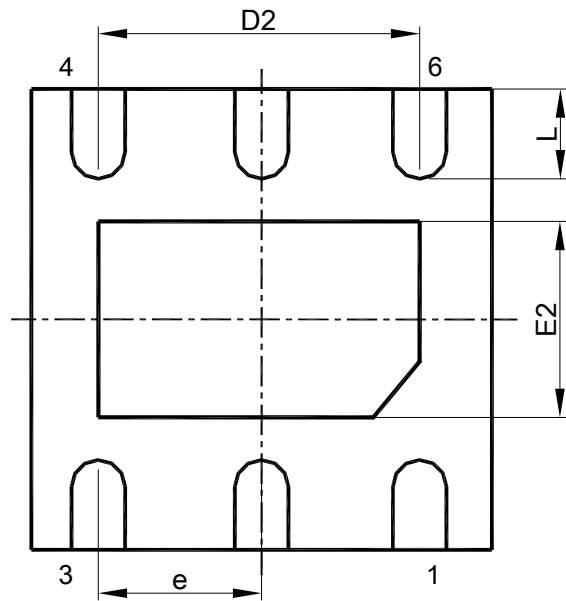

BOTTOM VIEW

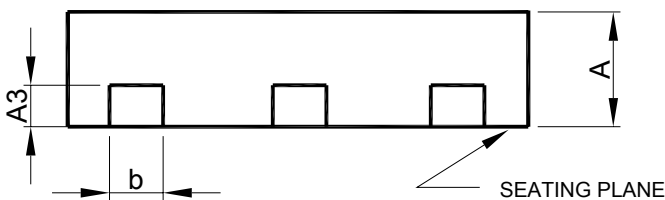

SIDE VIEW

SYMBOL	DFN 6L-2x2x0.75-0.65mm	
	MILLIMETERS	
	MIN.	MAX.
A	0.70	0.80
A3	0.20 BSC	
b	0.25	0.35
D	2.00 BSC	
D2	1.35	1.45
E	2.00 BSC	
E2	0.55	0.65
e	0.65 BSC	
L	0.25	0.35

- Note :
1. DIMENSION AND TOLERANCING CONFORM TO ASME Y14.5M-1994.
  2. CONTROLLING DIMENSIONS : MILLIMETER , CONVERTED INCH DIMENSION ARE NOT NECESSARILY EXACT.
  3. DIMENSION b APPLIES TO METALLIZED TERMINAL AND IS MEASURED BETWEEN 0.10 AND 0.25 mm FROM TERMINAL TIP.